

For MT8820C Radio Communication Analyzer

MX882000C W-CDMA Measurement Software

- MX882000C-011 HSDPA Measurement Software
- MX882000C-021 HSUPA Measurement Software
- MX882000C-031 HSPA Evolution Measurement Software
- MX882000C-032 DC-HSDPA Measurement Software
- MX882000C-033 DC-HSUPA Measurement Software
- MX882000C-034 4C-HSDPA Measurement Software



USED4TEST

Телефон: +7 (499) 685-7744

used@used4test.ru

www.used4test.ru



for W-CDMA/HSPA/ HSPA Evolution/ DC-HSPA/4G-HSDPA

Advanced High-speed Measurement Method and Batch Measurement Supporting the Manufacture of W-CDMA Terminals

The MX882000C W-CDMA Measurement Software is designed for measuring the transmitter and receiver of 3G W-CDMA terminals. When the MX882000C W-CDMA Measurement Software and MX882001C GSM Measurement Software are installed in the MT8820C Radio Communication Analyzer main frame, the Tx and Rx characteristics of dual-mode W-CDMA/GSM terminals, which are becoming very popular worldwide, can be evaluated using a single MT8820C unit.*

Installing the MX88207xC W-CDMA Ciphering Software* supports testing of coded voice communications between the MT8820C and W-CDMA terminal.

And manufacturing and inspection test times have been dramatically cut by incorporating advanced DSP and parallel measurement technologies.

Furthermore, several measurement items can be selected freely for batch measurement, and the number of measurements for each measurement item can be configured separately.

The one-touch operation supports easy and quick measurement of Tx and Rx characteristics, including transmit frequency, modulation accuracy, transmit power, spectrum emission mask, adjacent channel leakage power ratio, occupied bandwidth, and BER.

The built-in GPIB and Ethernet interface enables the MT8820C to be integrated into automated test systems for after-sales maintenance, as well as into automated production lines.

*: Require MX88205xC W-CDMA Call Processing Software.

Tests	3GPP TS 34.121	Test Items
Transmitter Tests	5.2	Maximum Output Power
	5.3	Frequency Error
	5.4.1	Open Loop Power Control in the Uplink
	5.4.2	Inner Loop Power Control in the Uplink
	5.4.3	Minimum Output Power
	5.4.4	Out-of-synchronisation Handling of Output Power
	5.5	Transmit ON/OFF Power
	5.6	Change of TFC
	5.7	Power setting in uplink compressed mode
	5.8	Occupied Bandwidth (OBW)
	5.9	Spectrum Emission Mask
	5.10	Adjacent Channel Leakage Power Ratio (ACLR)
	5.13.1	Error Vector Magnitude (EVM)
	5.13.2	Peak Code Domain Error (Only a single code)
5.13.3	UE Phase Discontinuity	
5.13.4	PRACH Preamble Quality	
Receiver Tests	6.2	Reference Sensitivity Level
	6.3	Maximum Input Level
Performance Test	7.2	Demodulation in Static Propagation Conditions

MX88200C W-CDMA Measurement Software

Transmitter Measurement

Transmit Power

The transmit power of the W-CDMA terminal can be measured when controlled to the maximum, minimum, and any other level. When two or more measurements are made, the maximum, average, and minimum results are displayed, supporting evaluation of the transmit power distribution. This functionality is also supported for other measurements.



Frequency Error

The frequency error of the W-CDMA terminal can be measured simultaneously as absolute error (kHz) and relative error (ppm).

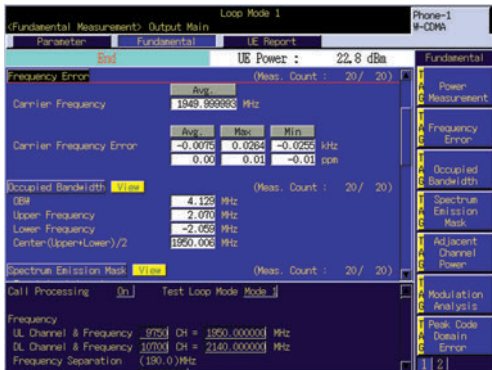

Occupied Bandwidth

The occupied bandwidth of the W-CDMA terminal can be measured.

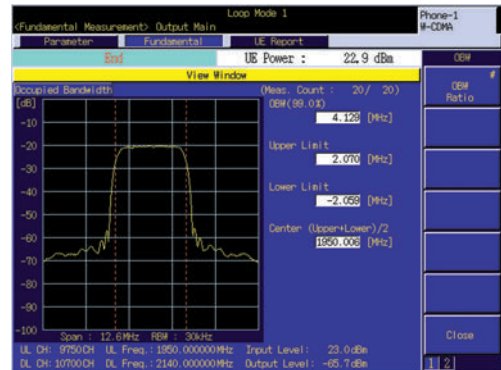

Spectrum Emission Mask

This support Pass/Fail testing of W-CDMA terminal spectrum emissions by checking whether the frequency components within ± 12.5 MHz of the center frequency are within the limits of the power frequency template.

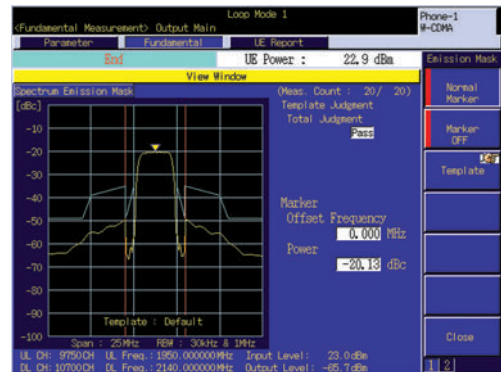

Spectrum Monitor

The spectrum of the W-CDMA terminal can be checked within the range of ± 2.5 MHz and ± 12.5 MHz of the carrier frequency. The peak spectrum in the zone can be detected by using the zone markers.



Adjacent Channel Leakage Power Ratio

The adjacent channel leakage power ratio of the W-CDMA terminal can be measured easily, and the advanced measurement architecture supports faster power measurement at points ± 5 MHz and ± 10 MHz from the center frequency.

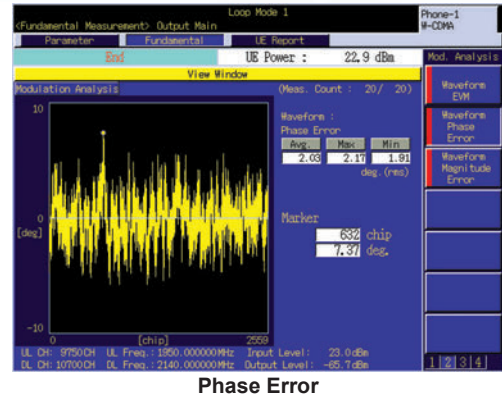

Phase Error

Modulation Analysis

The modulation accuracy of the W-CDMA terminal can be measured. In addition to the 3GPP-compliant error vector magnitude (EVM), the phase error, amplitude error, origin offset, I/Q level ratio, and peak code domain error can also be measured.

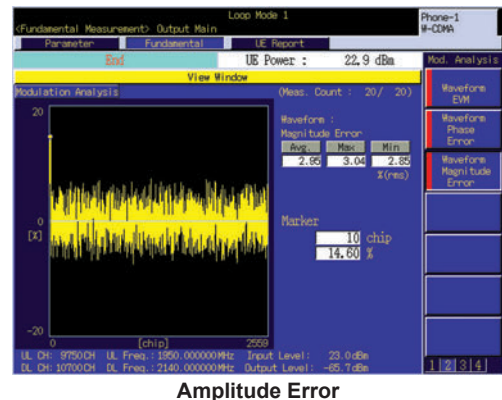

Amplitude Error

The vector error magnitude, phase error, and amplitude error at each chip point can be displayed as a waveform, which is very useful for R&D, repair and maintenance.

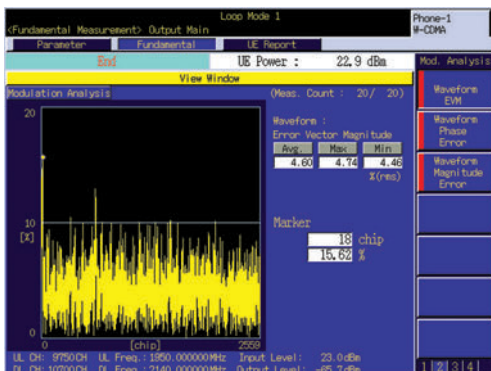

Vector Error

Open Loop Power Control

The transmit power for the RACH* preamble of the W-CDMA terminal is determined by the downlink RF signal power and RACH-related call processing parameters. The transmit power and template mask for the RACH preamble can be measured simultaneously in the time domain.

*: Random Access Channel

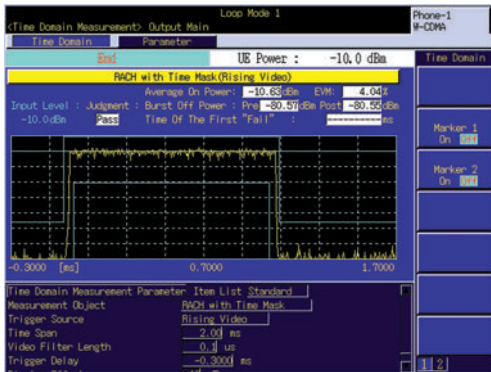

Receiver Measurement

Bit Error Rate (BER)

The bit error rate can be measured using the 3GPP-compliant loopback test mode.

In addition, feeding the demodulated data and clock signals from the W-CDMA terminal directly to the MT8820C supports bit error rate measurement. Both PN9 and PN15 can be set as the downlink RF signal data pattern.

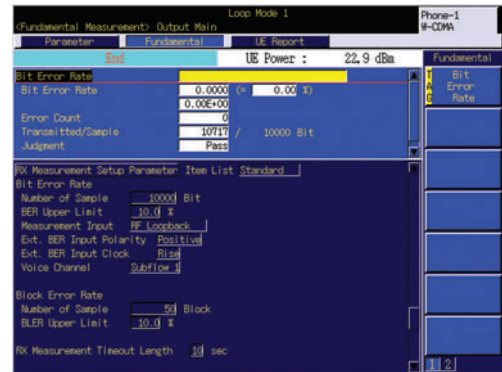

Inner Loop Power Control

Any specified TPC (Transmission Power Control) bits can be sent to the W-CDMA terminal.

The transmit power response of the W-CDMA terminal to power control can be measured in the time domain, and the transmit power for up to 1515 slots can be measured quickly as a batch.

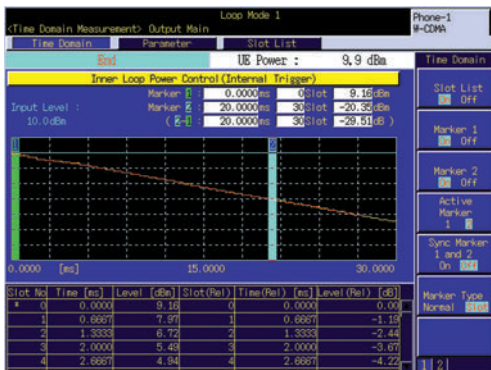

Performance Test

Block Error Rate (BLER)

The block error rate can be measured using test loop mode 2, supporting testing of DCH* demodulation in accordance with section 7.2.1 of the TS 34.121 3GPP standards.

*: Dedicated Channel

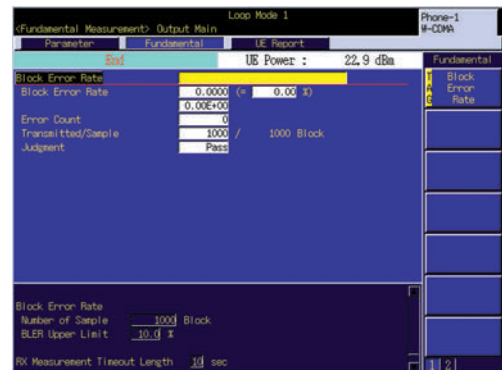

Downlink RF Signal Generator Functionality

The relative level of each of the CPICH*¹, P-CCPCH*², SCH*³, PICH*⁴, DPCH*⁵, S-CCPCH*⁶, and AICH*⁷ code channels can be set within the range of -30 to 0 dB. In addition, OCNS*⁸ and AWGN*⁹ can also be provided, supporting generation of any downlink modulation signal required for Tx and Rx tests. The RF output level can be set within the range of -140 to -10 dBm (MAIN I/O connectors) in 0.1 dB steps.

- *1: Common Pilot Channel
- *2: Primary Common Control Physical Channel
- *3: Synchronization Channel
- *4: Paging Indicator Channel
- *5: Dedicated Physical Channel
- *6: Secondary Common Control Physical Channel
- *7: Acquisition Indication Channel
- *8: Orthogonal Channel Noise Simulator
- *9: Additive White Gaussian Noise

Physical Channel	Parameter	Item List	Standard	Power/Tor
Downlink Physical Channel				(0.0) dB
Channel Level	Unit			
CPICH	Power (CPICH_Ec/Tor)			-3.3 dB
P-CCPCH	Power (P-CCPCH_Ec/Tor)			-3.3 dB
SCH	Power (SCH_Ec/Tor)			-3.3 dB
PICH	Power (PICH_Ec/Tor)			-3.3 dB
DPCH	Power (DPCH_Ec/Tor)			-10.3 dB
	Timing Offset			0 2556(0) chips
HS-SSCH	Power (HS-SSCH_Ec/Tor)			-30.0 dB
HS-FSSCH	Power (HS-FSSCH_Ec/Tor)			-30.0 dB
DDCH	Power (DDCH_Ec/Tor)			-3.0 dB
S-CCPCH	Power (S-CCPCH_Ec/Tor)			-3.0 dB
AICH	Power (AICH_Ec/Tor)			0.0 dB

Call Processing Parameter	Item List	Standard
Base Station ID		
Location Area Identification		
MSC	001	
MNC	01	
LAC	0001 H	

Call Processing

Connection Test

Various connection tests, such as registration, origination, termination, handover, terminal disconnect and network disconnect, can be tested using the call processing functionality. Moreover, voice from the W-CDMA terminal can be echoed back while calling call to test simple voice communications.

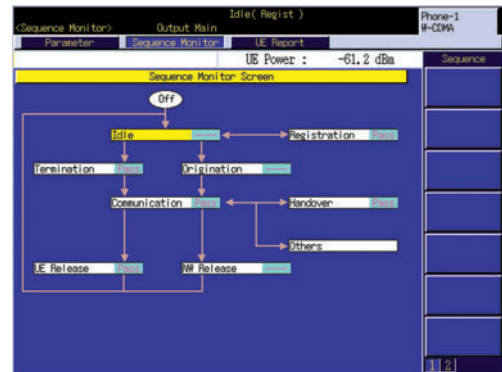

Mobile Terminal Report Monitor

The W-CDMA terminal transmit power and power class can be checked using this function.

Parameter	Fundamental	UE Report
UE Power		14.8 dBm
Initial UE Identity		
IMEI (DEC)		001010123456789
IMEI		357807000100650
RF Capability		
UE Power Class		1
Called Number		
Measurement Result for Current Cell		
Primary Scrambling Code		100
DPICH Ec/No		42 (-3.5 to -3 dB)
DPICH RSCP		45 (-73 to -72 dBm)
Pathloss		
Quality Measurement		
DL Transport Channel BLER_LOQ		0
UE Internal Measurement		
UE Transmitted Power		26 (15 to 16 dBm)
UE Rx-Tx Time difference		1026 (1025 to 1026 chip)
Intra Frequency Measurement		
Primary Scrambling Code		
DPICH Ec/No		

Higher Productivity

Reducing Test Time for W-CDMA/GSM Dual-mode Terminals

Intersystem Handover Control

Both the W-CDMA and GSM Tx and Rx characteristics of dual-mode W-CDMA/GSM terminals can be measured and voice handover from W-CDMA to GSM can be tested using the intersystem handover function, because the MT8820C application software switches quickly while the dual-mode terminal is handing over.

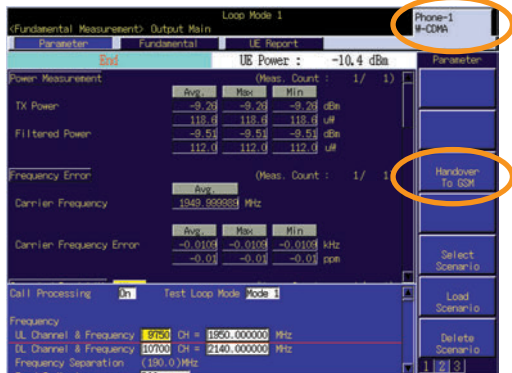
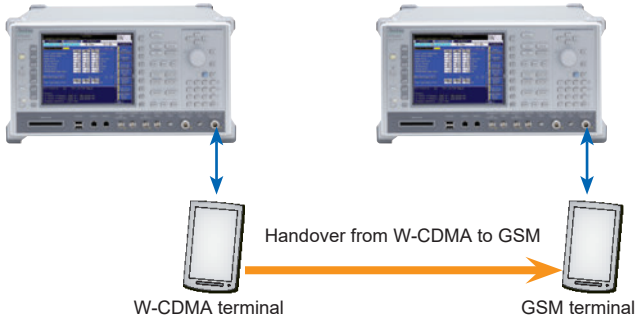

W-CDMA Measurement (Test loop mode or Voice communications)

High-speed system change from W-CDMA to GSM

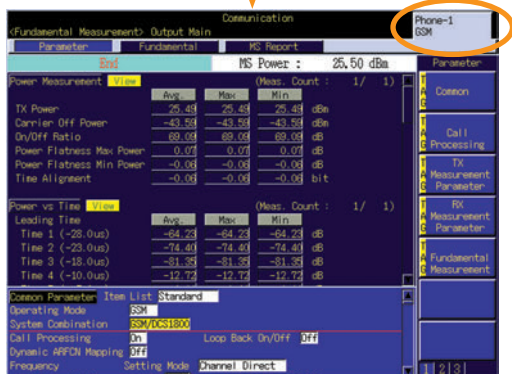

GSM Measurement (Loopback mode or Voice communications)

MX882050C-007/008/009 W-CDMA Band XII, XIII, XIV, XIX, XX, XXI, XI, IX

Supports W-CDMA Band XII, XIII, XIV, XIX, XX, XXI, XI, IX

The MX882050C-007 W-CDMA Band XII, XIII, XIV, XIX, XX, XXI option supports 3GPP Bands XII, XIII, XIV, XIX, XX, and XXI (700 MHz, 800 MHz, and 1.5 GHz) in the call processing mode. The MX882050C-008 W-CDMA Band XI option supports 3GPP Band XI (1.5 GHz) in the call processing mode. Moreover, the MX882050C-009 W-CDMA Band IX option supports 3GPP Band IX (1.7 GHz) in the call processing mode.

Band IX can be selected at Band Indicator, and SIB5 and SIB5bis can be selected at SIB5 Type.

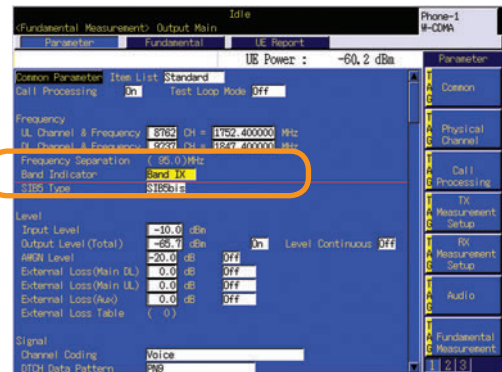

MX882050C-009 W-CDMA Band IX

* Requires MT8820C-002 + MX882001C.

MX882000C-001 W-CDMA Voice Codec

Real-time Voice Encoding/Decoding and Audio Measurement Functions

The MX882000C-001 W-CDMA Voice Codec supports real-time voice encoding and decoding in software, so end-to-end communication with terminals can be tested by installing this option and the MT8820C-011 Audio Board option. In addition, the audio transmitter and receiver can be tested while calling.

End-to-End Communications Test

This supports the end-to-end communications test between an Anritsu handset (A0058A/A0013) connected to the RJ11 connector on the MT8820C and a W-CDMA terminal. This option supports voice tests by dividing Tx and Rx paths.

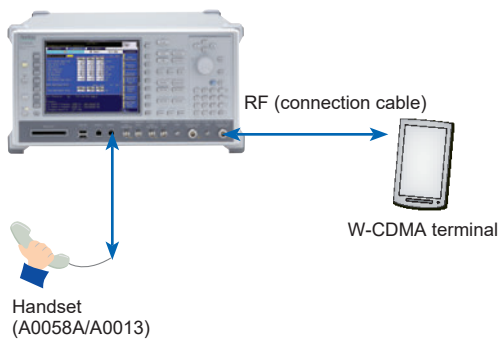

Audio Transmitter Measurement

The tone signal from the MT8820C AF Output connector is supplied to the microphone of the W-CDMA terminal and the audio transmitter characteristics of the W-CDMA terminal can be measured using the MT8820C to demodulate the uplink RF signal and measure the level, frequency, and distortion of demodulated tone signal.

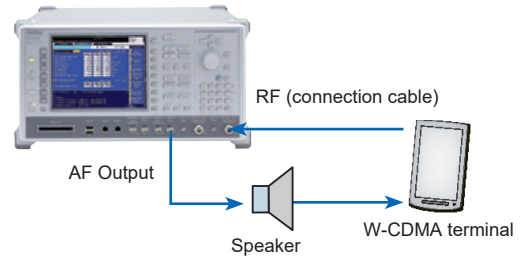

Audio Receiver Measurement

The tone signal demodulated by the W-CDMA terminal is supplied to the MT8820C AF Input connector and the audio receiver characteristics of the W-CDMA terminal can be measured by using the MT8820C to measure the level, frequency, and distortion of the tone signal at the AF Input.

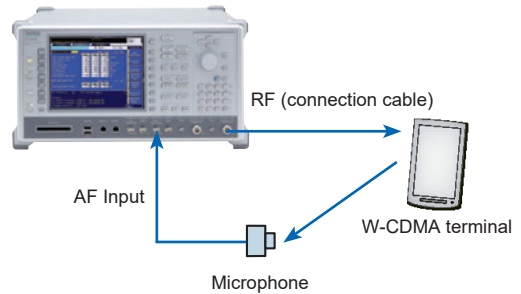

MX882050C-002, MX882051C-002 W-CDMA External Packet Data

Packet Communication Data Transfer Test

The MX88205xC-002 W-CDMA External Packet Data option supports data transfer to/from external equipment via the Ethernet port. End-to-end Ping interconnect test between an application server connected to the MT8820C and the W-CDMA terminal or client PC connected to the W-CDMA terminal can be tested using the MX882050C-002 and MX882051C-002.

External PPP Packet Test

The MT8820C with PPP server terminates PPP packets from the W-CDMA terminal and sends IP packets to the application server via the Ethernet port. It also converts IP packets from the application server to PPP packets and sends them to the W-CDMA terminal.

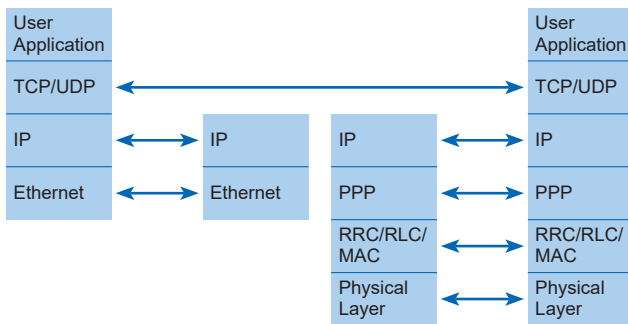

Protocol Stack for External PPP Packet Test

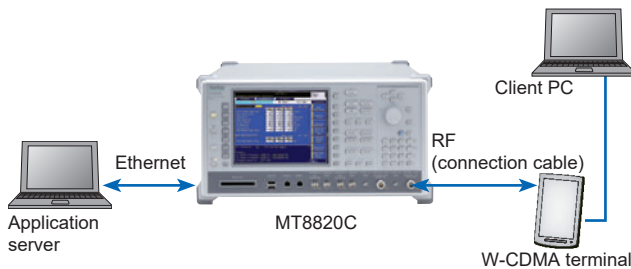

Sample MT8820C Connection

External IP Packet Test

The MT8820C sends IP packets from the W-CDMA terminal to the application server. It also sends IP packets from the application server to the W-CDMA terminal.

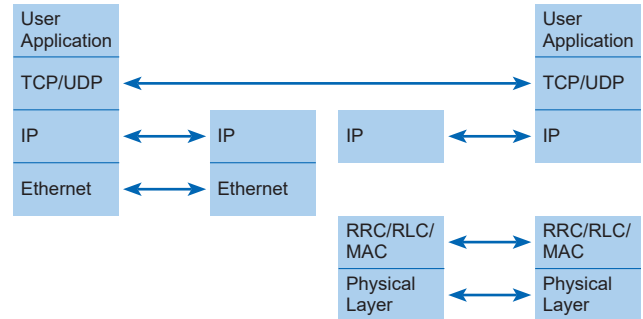

Protocol Stack for External IP Packet Test



Sample MT8820C Connection

MX882050C-003 MX882051C-003 W-CDMA Video Phone Test End-to-End Video Phone Test

End-to-end video communication via the Ethernet port in the rear panel of the MT8820C can be tested using the MX882050C-003 and MX882051C-003 W-CDMA Video Phone Test. End-to-end video communication with a single MT8820C can be tested by installing this software option and the Parallel Phone Measurement Hardware.

End-to-End Test

End-to-end Video Communication Test with Single MT8820C Configured with Parallel Phone Measurement Hardware

End-to-end video communications between W-CDMA terminals can be tested by originating a call from the W-CDMA terminal connected to Phone2 (or Phone1) while holding Phone1 (or Phone2) ready to receive a call using Start Call.

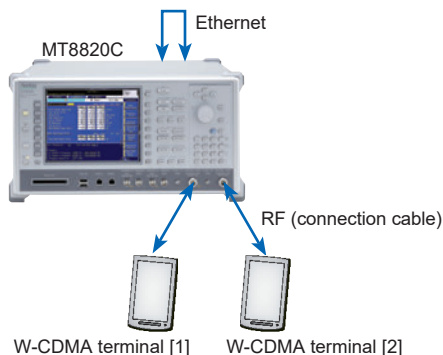

End-to-end Video Communication Test using Two MT8820C Units

End-to-end video communication between W-CDMA terminals can be tested by originating a call from the W-CDMA terminal connected to the MT8820C Unit 2 (or MT8820C Unit 1) while holding the MT8820C Unit 1 (or MT8820C Unit 2) ready to receive a call using Start Call.

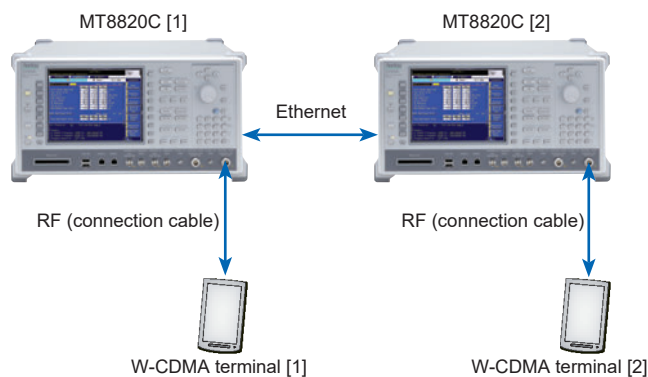

MX882000C-011 HSDPA Measurement Software Utilizing an Advanced High-speed Measuring Method and Offering Batch Measurements to Support HSDPA Terminal Production

The MX882000C-011 HSDPA Measurement Software supports measurement of Tx and Rx characteristics of HSDPA terminals. It can generate the FRC (Fixed Reference Channel) signals used for testing HSDPA terminals with HS-DSCH category 1 to 6, 11, and 12 (3.6 Mbps).

Tests	3GPP TS 34.121	Test items
Transmitter Tests	5.2A	Maximum Output Power with HS-DPCCH (Release 5 Only)
	5.2AA	Maximum Output Power with HS-DPCCH (Release 6 and later)
	5.2C	UE relative code domain power accuracy
	5.7A	HS-DPCCH power control
	5.9A	Spectrum Emission Mask with HS-DPCCH
	5.10A	Adjacent Channel Leakage Power Ratio (ACLR) with HS-DPCCH
	5.13.1A	Error Vector Magnitude (EVM) with HS-DPCCH
Receiver Tests	5.13.1AA	Error Vector Magnitude (EVM) and phase discontinuity with HS-DPCCH
	5.13.2A	Relative Code Domain Error with HS-DPCCH (Only a single code)
	6.3A	Maximum Input Level with HS-PDSCH Reception (16QAM)

HSDPA FRC Signals

HSDPA FRC Signal

FRC H-Set 1 to 5 can be set as test signal to measure Tx and Rx characteristics of HSDPA terminals, and both QPSK and 16QAM modulation types are supported too.

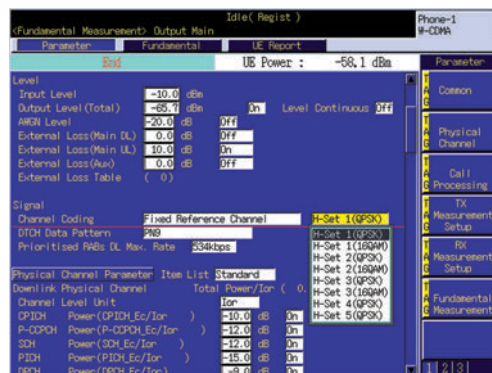

Parameters for HSDPA Measurement

The various for HSDPA measurement parameters, such as CQI feedback cycle and repetition factor can be configured.

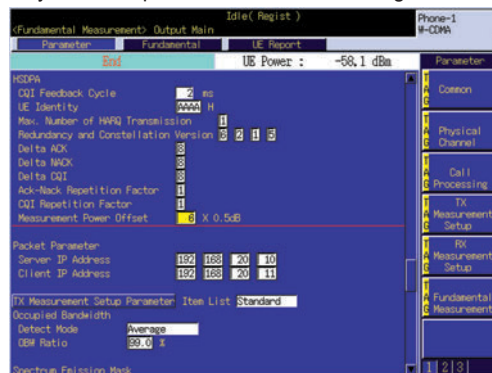

Transmitter Measurement

HS-DPCCH Power Control, Modulation Analysis, Code Domain Power

At measurement in the time domain, the power step at the HS-DPCCH slot boundary, modulation, and code domain power are measured.

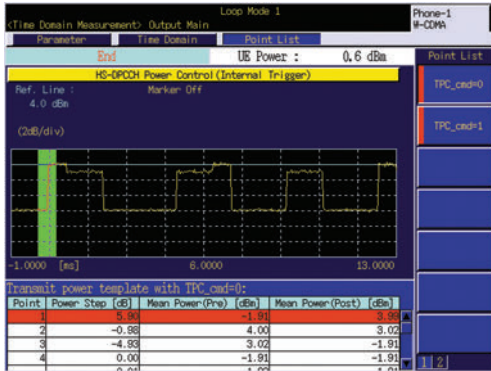

HS-DPCCH Power Control

Receiver Measurement

HSDPA Throughput

The HSDPA throughput can be measured by counting the number of ACK blocks from the HSDPA terminal.

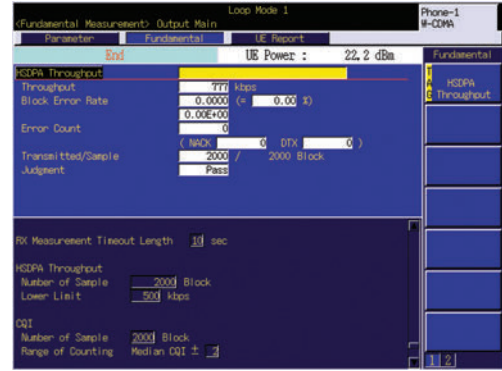

Transmit Power, Spectrum Emission Mask, Adjacent Channel Leakage Power Ratio

The transmit power, spectrum emission mask and adjacent channel leakage power ratio of the HS-DPCCH transmission slot are measured.



CQI Measurement

Statistical analysis can be performed on CQI values reported by the HSDPA terminal. The maximum, minimum, average, and median values can also be displayed.

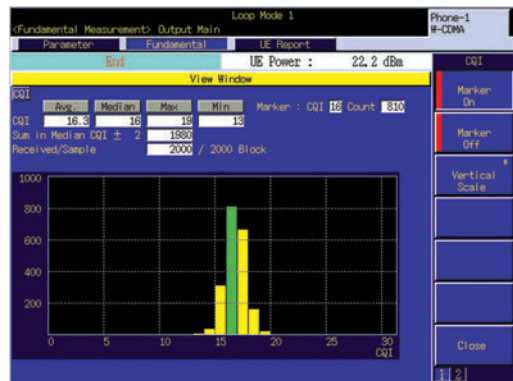

MX882000C-013 HSDPA High Data Rate

Supports following signals for HSDPA throughput measurement.

Parameter (Channel Coding)	Maximum data rate (Prioritized RABs DL Max Rate)	Explanation
H-Set 6 (QPSK)	3219 kbps	3GPP-defined signal to test throughput of HSDPA terminal for HS-DSCH categories 7 and 8 (7.2 Mbps class) (QPSK modulation)
H-Set 6 (16QAM)	4689 kbps	3GPP-defined signal to test throughput of HSDPA terminal for HS-DSCH categories 7 and 8 (7.2 Mbps class) (16QAM modulation)
Category 6, Max.	3649 kbps	Signal to test throughput of HSDPA terminal for HS-DSCH category 6 (3.6 Mbps class) with maximum data rate
Category 8, Max.	7205.5 kbps	Signal to test throughput of HSDPA terminal for HS-DSCH category 8 (7.2 Mbps class) with maximum data rate
Category 9, Max.	1012.5 kbps	Signal to test throughput of HSDPA terminal for HS-DSCH category 9 (10 Mbps class) with maximum data rate
Category 10, Max.	13976 kbps	Signal to test throughput of HSDPA terminal for HS-DSCH category 10 (14 Mbps class) with maximum data rate

Test Signal Parameter

FRC H-Set 6 (QPSK/16QAM), Category 6, Max., Category 8, Max., Category 9, Max., Category 10, Max. test signals can be selected for HSDPA throughput measurement.

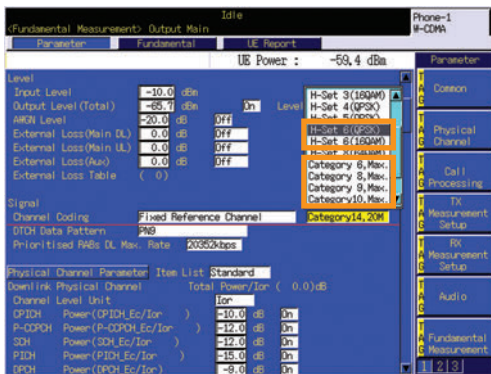

HSDPA High Data Rate Throughput Measurement

ACKs sent from the HSDPA terminal are counted and the throughput is measured.

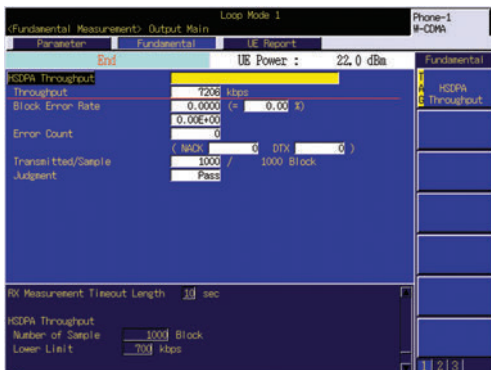

Ex. Category 8, Max.

MX882050C-011 HSDPA External Packet Data Packet Communications Data Transfer Test

The MX882050C-011 HSDPA External Packet Data option supports data transfer to/from external equipment via the Ethernet port in the rear panel of the MT8820C. End-to-end Ping interconnect test between the application server connected to the MT8820C and the HSDPA terminal or client PC connected to the HSDPA terminal can be tested using the MX882050C-011 option. The maximum data rate is 388 kbps.

External IP Packet Test

The MT8820C sends IP packets from the HSDPA terminal to the application server. It also sends IP packets from the application server to the HSDPA terminal.

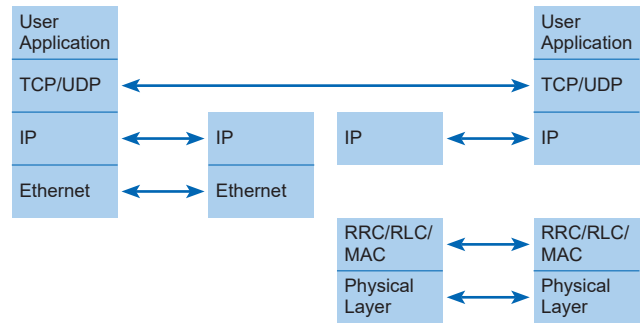
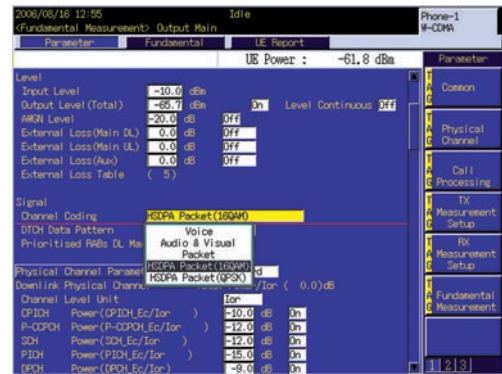

Sample MT8820C Connection

MX882000C-021 HSUPA Measurement Software

HSUPA terminals RF Tx Measurement, and Throughput Monitoring

The MX882000C-021 HSUPA Measurement Software supports Tx measurements of HSUPA terminals. It can generate the signals used for testing HSUPA terminals with E-DCH category 1 to 6 (5.76 Mbps), and TTI 2 and 10 ms.

Tests	3GPP TS 34.121	Test Items
Transmitter Tests	5.2B	Maximum Output Power with HS-DPCCH and E-DCH
	5.2D	UE Relative Code Domain Power Accuracy for HS-DPCCH and E-DCH
	5.9B	Spectrum Emission Mask with E-DCH
	5.10B	Adjacent Channel Leakage Power Ratio (ACLR) with E-DCH
	5.13.2B	Relative Code Domain Error with HS-DPCCH and E-DCH

HSUPA Parameter

HSUPA RF Transmitter Measurement Signals

The TTI 2, 10 ms can be selected as test signals including E-DCH for Tx measurements of HSUPA terminal supporting categories 1 to 6.*

*: TTI 2 ms (16QAM) and Category 7, Max. are selectable when the MX882000C-021 and MX882000C-031 HSPA Evolution Measurement Software options are installed.

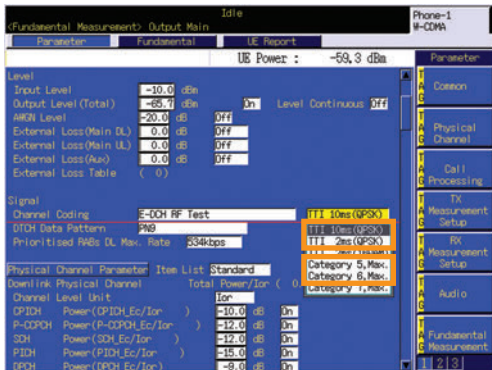

Transmitter Measurement

Transmit Power, Spectrum Emission Mask, Adjacent Channel Leakage Power Ratio

The transmit power, spectrum emission mask, and adjacent channel leakage power ratio at HS-DPCCH and E-DCH transmission are measured.



Code Domain Power

The code domain power of the E-DCH are measured.

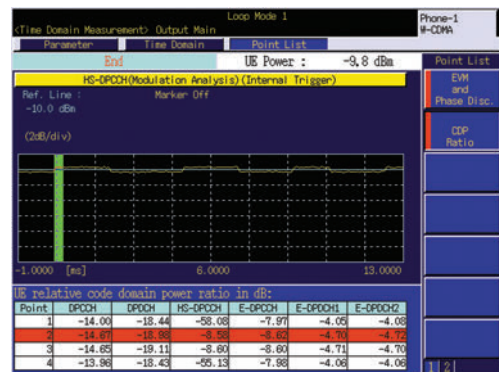

Throughput Monitor

The E-DCH throughput is calculated from the E-TFCI notification from the HSUPA terminal. In addition, the E-TFCI statistic (average, median and minimum) are displayed.

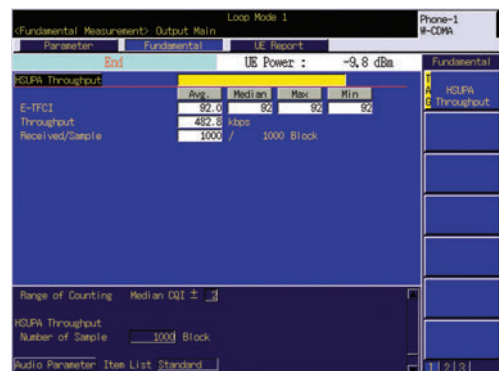

MX882000C-031 HSPA Evolution Measurement Software

HSPA Evolution Terminals RF TRx and Throughput Measurement

MX882000C-031 HSPA Evolution Measurement Software supports TRx measurements (measurement items defined in 3GPP TS 34.121 shown the table below) of HSPA Evolution terminals.

Tests	3GPP TS 34.121	Test items
Transmitter Tests	5.2E	UE Relative Code Domain Power Accuracy for HS-DPCCH and E-DCH with 16QAM
	5.13.1AAA	EVM and IQ origin offset for HS-DPCCH and E-DCH with 16QAM
	5.13.2C	Relative Code Domain Error for HS-DPCCH and E-DCH with 16QAM
Receiver Tests	6.3B	Maximum Input Level for HS-PDSCH Reception (64QAM)

Transmitter Measurement

UE Relative Code Domain Power Accuracy, Relative Code Domain Error

UE Relative Code Domain Power Accuracy and Relative Code Domain Error for HS-DPCCH and E-DCH with 16QAM are measured.

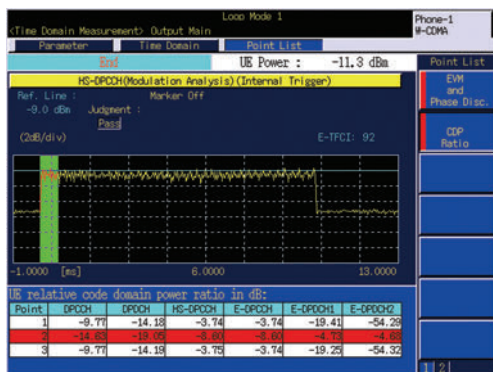

Receiver Measurement

HSDPA Throughput with 64QAM

The HSDPA throughput with 64QAM can be measured by counting the number of ACK blocks from the terminal.

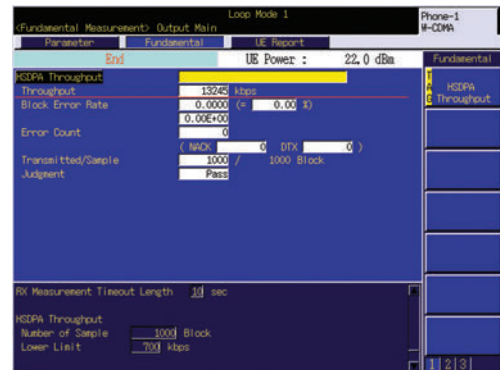

Test Signal Parameter

FRC H-Set 8 (64QAM), and Category 14, Max. test signals can be selected for throughput measurement.

Parameter (Channel Coding)	Maximum data rate (Prioritized RABs DL Max Rate)	Explanation
H-Set 8 (64QAM)	13245 kbps	3GPP-defined signal to test throughput of HSDPA terminal for HS-DSCH category 13 (17.6 Mbps class) and category 14 (21 Mbps class) (64QAM modulation)
Category 14, Max.	21098 kbps	Signal to test throughput of HSDPA terminal for HS-DSCH category 14 (21 Mbps class) with maximum data rate

MX882000C-032 DC-HSDPA Measurement Software

DC-HSDPA Terminals RF Rx, Throughput and CQI Measurement

Measurements of key Rx characteristics related to 3GPP-compliant DC-HSDPA, Throughput, and CQI are supported.

Tests	3GPP TS 34.121	Test items
Receiver Tests	6.2A	Reference Sensitivity Level for DC-HSDPA
	6.3C	Maximum Input Level for DC-HSDPA Reception (16QAM)
	6.3D	Maximum Input Level for DC-HSDPA Reception (64QAM)

Parameter (DC-HSDPA Set of Parameters)	Maximum data rate (Prioritized RABs DL Max Rate)	Explanation
H-Set 1A (16QAM)	1554 kbps	3GPP-defined signal to test throughput of DC-HSDPA terminal (16QAM modulation)
H-Set 8A (64QAM)	26504 kbps	3GPP-defined signal to test throughput of DC-HSDPA terminal (64QAM modulation)
H-Set 12 (QPSK)	120 kbps	3GPP-defined signal to test throughput of DC-HSDPA terminal (QPSK modulation)
Category 22, Max.	27952 kbps	Signal to test throughput of DC-HSDPA terminal for HS-DSCH category 22 with maximum data rate
Category 24, Max.	42192 kbps	Signal to test throughput of DC-HSDPA terminal for HS-DSCH category 24 (42 Mbps class) with maximum data rate

Receiver Measurement

DC-HSDPA call processing can be measured using the two RF ports of the MT8820C.

Moreover, the number of ACK blocks sent from the mobile terminal can be counted and two-cell throughput can be measured. Measurement of the highest throughput (42 Mbps) in HS-DSCH category 24 is supported.

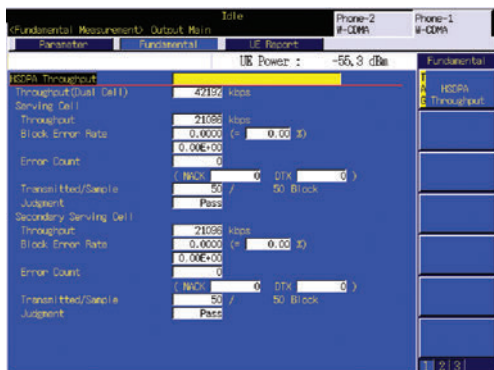

Throughput



Sample MT8820C Connection

* MT8820C-012, MT8820C-001 2 sets, MX882000C, MX882000C-011, MX882000C-021, MX882000C-031, MX882000C-032, and MX882050C required for DC-HSDPA measurements (MT8820C 1unit)
* DC-HSDPA only supported by MT8820C

* For terminal connectivity, contact your Anritsu sales representative.

MX882000C-033 DC-HSUPA Measurement Software

DC-HSUPA Terminals RF Tx Measurement

The MX882000C-033 DC-HSUPA Measurement Software supports Tx measurement of DC-HSUPA terminals. It can generate the signals used for testing DC-HSUPA terminals with E-DCH TTI 2 ms.

Tests	3GPP TS 34.121*	Test items
Transmitter Tests	5.2BA	UE Maximum Output Power for DC-HSUPA (QPSK)
	5.2BB	UE Maximum Output Power for DC-HSUPA (16QAM)
	5.2DA	UE Relative Code Domain Power Accuracy for HS-DPCCH and EDCH for DC-HSUPA with QPSK
	5.2EA	UE Relative Code Domain Power Accuracy for DC-HSUPA with 16QAM
	5.3A	Frequency Error for DC-HSUPA
	5.4.1A	Open Loop Power Control in the Uplink for DC-HSUPA
	5.4.2A	Inner Loop Power Control in the Uplink for DC-HSUPA
	5.4.3A	Minimum Output Power for DC-HSUPA
	5.8A	Occupied Bandwidth (OBW) for DC-HSUPA
	5.9C	Additional Spectrum Emission Mask for DC-HSUPA (QPSK)
	5.9D	Additional Spectrum Emission Mask for DC-HSUPA (16QAM)
	5.10C	Adjacent Channel Leakage Power Ratio (ACLR) with E-DCH for DC-HSUPA (QPSK)
	5.10D	Adjacent Channel Leakage Power Ratio (ACLR) with E-DCH for DC-HSUPA (16QAM)
	5.13.2BA	Relative Code Domain Error with HS-DPCCH and E-DCH for DC-HSUPA
	5.13.2CA	Relative Code Domain Error for HS-DPCCH and E-DCH with 16QAM for DC-HSUPA
5.13.5	In-band emission for HSUPA	

*: 3GPP TS 34.121 (V10.6.0, 2013-03)

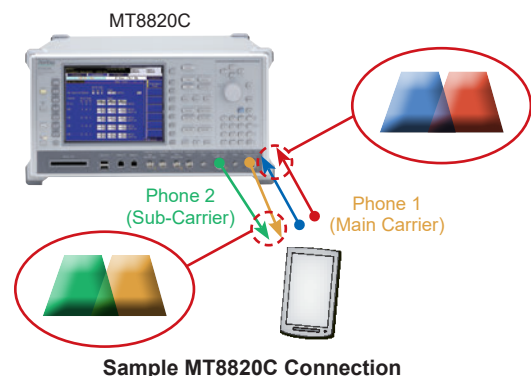

Sample MT8820C Connection

MX882000C-034 4C-HSDPA Measurement Software

3C/4C-HSDPA Terminals RF Rx and Throughput Measurement

MX882000C-034 4C-HSDPA Measurement Software supports RX measurements (measurement items defined in 3GPP TS 34.121 shown below) of 3C/4C-HSDPA terminals.

It can generate the FRC (Fixed Reference Channel) signals used for testing HSDPA terminals with HS-DSCH category 22, 24, 29, 31 (84 Mbps)*.

Tests	3GPP TS 34.121*	Test items
Receiver Tests	6.2C	Reference Sensitivity Level for Single band 4C-HSDPA
	6.2D	Reference Sensitivity Level for Dual band 4C-HSDPA
	6.3G	Maximum Input Level for 4C-HSDPA Reception (16QAM)
	6.3H	Maximum Input Level for 4C-HSDPA Reception (64QAM)

*: 3GPP TS 34.121 (V10.6.0, 2013-03)

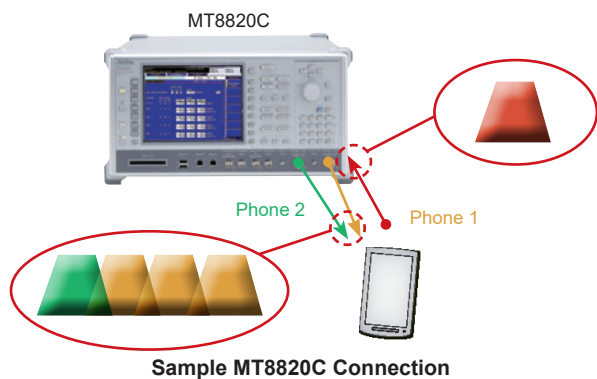

* Phone1, Phone2: max 3 cells per port and totally max. 4 cells

Specifications

* Typical values are for reference only; specifications are not guaranteed.

● MT8820C-001 W-CDMA Measurement Hardware, MX882000C W-CDMA Measurement Software, MX88205xC W-CDMA Call Processing Software

Modulation Analysis	Frequency: 300 MHz to 2.7 GHz Input level: -30 to +35 dBm (Main) Carrier frequency accuracy: \pm (Setting frequency \times Reference oscillator accuracy + 10 Hz) Modulation accuracy (residual vector error): $\leq 2.5\%$ (at input of single DPCCCH and single DPDCH)
RF Power	Frequency: 300 MHz to 2.7 GHz Input level: -65 to +35 dBm (Main) Measurement accuracy: ± 0.3 dB (typ.), ± 0.5 dB (-25 to +35 dBm), ± 0.7 dB (-55 to -25 dBm), ± 0.9 dB (-65 to -55 dBm) *After calibration, 10° to 40°C Linearity: ± 0.2 dB (-40 to 0 dB, ≥ -55 dBm), ± 0.4 dB (-40 to 0 dB, ≥ -65 dBm) Measurement object: DPCH, PRACH
Occupied Bandwidth	Frequency: 300 MHz to 2.7 GHz Input level: -10 to +35 dBm (Main)
Adjacent Channel Leakage Power Ratio	Frequency: 300 MHz to 2.7 GHz Input level: -10 to +35 dBm (Main) Measurement points: ± 5 MHz, ± 10 MHz Measurement range: ≥ 50 dB (± 5 MHz), ≥ 55 dB (± 10 MHz)
RF Signal Generator	Output frequency: 300 MHz to 2.7 GHz (1 Hz step) Channel level CPICH, P-CCPCH, SCH, PICH, DPCH, S-CCPCH, AICH : Off, -30 to 0 dB [0.1 dB step, relative level for Ior (total level)] OCNS : Off, Auto-setting Channel level accuracy: ± 0.2 dB (relative level accuracy for Ior) AWGN level: Off, -20 to +5 dB [0.1 dB step, relative level for Ior (total level)] AWGN level accuracy: ± 0.2 dB (relative level accuracy for Ior)
Error Rate Measurement	Measurement items: BER, BLER Measurement object: Loopback data imposed on uplink DTCH (BER, BLER), Serial data input from rear-panel call processing I/O port (BER)
Call Processing	Call controlling: Registration, Origination, Termination, Handover, Network disconnect, Terminal disconnect (executes each processing conforming to 3GPP standards and performs Pass/Fail evaluation) Mobile terminal controlling: Output level, Loopback (executes each mobile terminal control conforming to 3GPP standards)

● MX882000C-011 HSDPA Measurement Software

RF Power	Frequency: 300 MHz to 2.7 GHz Input level: -65 to +35 dBm (Main) Measurement accuracy: ± 0.3 dB (typ.), ± 0.5 dB (-25 to +35 dBm), ± 0.7 dB (-55 to -25 dBm), ± 0.9 dB (-65 to -55 dBm) *After calibration, 10° to 40°C Linearity: ± 0.2 dB (-40 to 0 dB, ≥ -55 dBm), ± 0.4 dB (-40 to 0 dB, ≥ -65 dBm) Measurement object: HS-DPCCH
Throughput Measurement	Functions: Transmit HS-SCCH, HS-PDSCH based on Fixed Reference Channel Measurement items: BLER, Throughput Measurement object: ACK and NACK data imposed on HS-DPCCH
CQI Measurement	Function: Statistical analysis of CQI on HS-DPCCH values reported from a mobile terminal
Call Processing	Call controlling: Registration, Call processing for Fixed Reference Channel (executes each processing conforming to 3GPP standards and performs Pass/Fail evaluation) Mobile terminal controlling: Output level (executes each mobile terminal control conforming to 3GPP standards)

● MX882000C-013 HSDPA High Data Rate

Throughput Measurement	Functions: HS-SCCH and HS-PDSCH transfer according to fixed reference channel (H-Set 6) HS-SCCH and HS-PDSCH transfer according to HSDPA Full Rate for category 6, 8, 9, and 10 Measured items: BLER, Throughput Measurement object: ACK and NACK data imposed on uplink HS-DPCCH
Call Processing	Call controlling: Fixed Reference Channel (H-Set 6), HSDPA Full Rate (category 6, 8, 9, and 10) (executes each processing conforming to 3GPP standards and performs Pass/Fail evaluation)

● MX882000C-021 HSUPA Measurement Software

RF Power	Frequency: 300 MHz to 2.7 GHz Input level: -65 to +35 dBm (Main) Measurement accuracy: ± 0.3 dB (typ.), ± 0.5 dB (-25 to +35 dBm), ± 0.7 dB (-55 to -25 dBm), ± 0.9 dB (-65 to -55 dBm) *After calibration, 10° to 40°C Linearity: ± 0.2 dB (-40 to 0 dB, ≥ -55 dBm), ± 0.4 dB (-40 to 0 dB, ≥ -65 dBm) Measurement object: DPCH, HS-DPCCH, E-DPCCH, E-DPDCH
Call Processing	Call controlling: Registration, Call processing for E-DCH RF Test (executes each processing conforming to 3GPP standards and performs Pass/Fail evaluation) Mobile terminal controlling: Output level (executes each mobile terminal control conforming to 3GPP standards)

● **MX882000C-031 HSPA Evolution Measurement Software**

Throughput Measurement	Functions: Transmit HS-SCCH, HS-PDSCH based on Fixed Reference Channel (H-Set 8) Transmit HS-SCCH, HS-PDSCH based on HSDPA full rate for Category 13 and 14 Measurement items: BLER, Throughput Measurement object: ACK and NACK data imposed on HS-DPCCH
Call Processing	Call control: Fixed Reference Channel (H-Set 8) HSDPA Full Rate (Category 13 and 14) and E-DCH RF Test (16QAM) (executes operation conforming to 3GPP standards and performs Pass/Fail evaluation) Mobile terminal controlling: Output level (executes each mobile terminal control conforming to 3GPP standards)

● **MX882000C-032 DC-HSDPA Measurement Software**

Throughput Measurement	Functions: Transmit HS-SCCH and HS-PDSCH based on Fixed Reference Channel Measurement items: BLER, Throughput Measurement object: ACK and NACK applied to HS-DPCCH
CQI Measurement	Measurement object: Periodic CQI reports over HS-DPCCH
Call Processing	Call control: Fixed Reference Channel (H-Set 1A, H-Set 8A, H-Set 12) and at Full Rate from Category 22 and 24 HSDPA terminals (executes operation conforming to 3GPP standards and performs Pass/Fail evaluation)

● **MX882000C-033 DC-HSUPA Measurement Software**

RF Power	Frequency range: 300 MHz to 2.7 GHz Input level: -65 to +35 dBm (Main) Measurement accuracy: ± 0.3 dB (typ.), ± 0.5 dB (-25 to +35 dBm), ± 0.7 dB (-55 to -25 dBm), ± 0.9 dB (-65 to -55 dBm) *After calibration, at 10° to 40°C Linearity: ± 0.2 dB (-40 to 0 dB, ≥ -55 dBm), ± 0.4 dB (-40 to 0 dB, ≥ -65 dBm) Measurement object: DPCH, HS-DPCCH, E-DPCCH, E-DPDCH
Call Processing	Call control: Location registration, E-DCH RF Test (executes operation conforming to 3GPP standards and performs Pass/Fail evaluation) UE control: Output level (UE control conforming to the 3GPP standards can be performed)

● **MX882000C-034 4C-HSDPA Measurement Software**

Throughput Measurement	Functions: Transmit HS-SCCH and HS-PDSCH based on Fixed Reference Channel Transmit HS-SCCH and HS-PDSCH according to HSDPA Full Rate of Category 22, 24, 29, and 31 Measurement items: BLER, Throughput Measurement object: ACK and NACK applied to HS-DPCCH
CQI Measurement	Measurement object: Periodic CQI reports from UE over HS-DPCCH
Call Processing	Call control: Fixed Reference Channel (H-Set 1A, H-Set 8A, H-Set 12, H-Set 1B, H-Set 8B, H-Set 1C, H-Set 8C) and HSDPA Full Rate (Category 22, 24, 29, and 31) (executes operation conforming to 3GPP standards and performs Pass/Fail evaluation)

● **MT8820C-011 Audio Board, MX882000C-001 W-CDMA Voice Codec**

Voice Codec	AMR 12.2 kbps
Codec Level Adjustment	Encoder input gain: -3 to +3 dB, 0.01 dB step Handset microphone volume: 0, 1, 2, 3, 4, 5 Handset speaker volume: 0, 1, 2, 3, 4, 5
AF Output	Frequency range: 30 Hz to 10 kHz, 1 Hz step Carrier frequency accuracy: \pm (Setting frequency \times Reference oscillator accuracy + 0.1 Hz) Setting range: 0 Vpeak to 5 Vpeak (AF Output) Setting resolution: 1 mV (≤ 5 Vpeak), 100 μ V (≤ 500 mVpeak), 10 μ V (≤ 50 mVpeak) Accuracy: ± 0.2 dB (≥ 10 mVpeak, ≥ 50 Hz), ± 0.3 dB (≥ 10 mVpeak, < 50 Hz) Waveform distortion: ≤ 30 kHz band ≤ -60 dB (500 mVpeak, ≤ 5 kHz), ≤ -54 dB (≥ 70 mVpeak) Output impedance: ≤ 1 Ω Max. output current: 100 mA
AF Input	Frequency range: 50 Hz to 10 kHz Input voltage range: 1 mVpeak to 5 Vpeak (AF Input) Max. allowable input voltage: 30 Vrms Input impedance: 100 k Ω
Frequency Measurement	Accuracy: \pm (Reference oscillator accuracy + 0.5 Hz)
Level Measurement	Accuracy: ± 0.2 dB (≥ 10 mVpeak, ≥ 50 Hz), ± 0.4 dB (≥ 1 mVpeak, ≥ 1 kHz)
SINAD Measurement	Frequency: 1 kHz in ≤ 30 kHz band ≥ 60 dB (≥ 1000 mVpeak), ≥ 54 dB (> 50 mVpeak), ≥ 46 dB (≥ 10 mVpeak)
Distortion Rate Measurement	Frequency: 1 kHz in ≤ 30 kHz band ≤ -60 dB (≥ 1000 mVpeak), ≤ -54 dB (> 50 mVpeak), ≤ -46 dB (≥ 10 mVpeak)

● **MX882050C-002, MX882051C-002 W-CDMA External Packet Data**

Ethernet	10Base-T
Data Rate	DL: 384 kbps, UL: 64 kbps
Server IP Address	0.0.0.0 to 255.255.255.255
Client IP Address	0.0.0.0 to 255.255.255.255
Channel Coding	Interactive or background UL: 64 kbps DL: 384 kbps/PS RAB
DTCH Data Pattern	External PPP packet, External IP packet

● **MX882050C-011 HSDPA External Packet Data**

Ethernet	10Base-T
Data Rate	DL: 267 kbps maximum for QPSK 388 kbps maximum for 16QAM UL: 64 kbps
Server IP Address	0.0.0.0 to 255.255.255.255
Client IP Address	0.0.0.0 to 255.255.255.255
Channel Coding	Interactive or background UL: 64 kbps DL: 267 kbps/PS RAB for QPSK 388 kbps/PS RAB for 16QAM
DTCH Data Pattern	External IP packet

● **MX882050C-003, MX882051C-003 W-CDMA Video Phone Test**

Ethernet	10Base-T
Data Rate	DL: 64 kbps, UL: 64 kbps
Channel Coding	Conversation/Unknown UL: 64 kbps DL: 64 kbps/CS RAB

● **MX882050C-007 W-CDMA Band XII, XIII, XIV, XIX, XX, XXI**

Band Indicator	Band XII, XIII, XIV, XIX, XX, XXI can be selected
----------------	---------------------------------------------------

● **MX882050C-008 W-CDMA Band XI**

Frequency Separation	Linked with Channel and set to 48.0 MHz
Band Indicator	Band XI can be selected

● **MX882050C-009 W-CDMA Band IX**

Band Indicator	Band IX can be selected
SIB5 Type	Auto, SIB5, and SIB5bis can be selected

Ordering Information

Please specify the model/order number, name and quantity when ordering.
The names listed in the chart below are Order Names. The actual name of the item may differ from the Order Name.

Model/Order No.	Name	Model/Order No.	Name
MT8820C	Main frame Radio Communication Analyzer	MX882007C-021	TD-SCDMA HSUPA Measurement Software*2 (requires MT8820C-001, MT8820C-007, MX882007C, MX882007C-011)
	Standard accessories	MX882010C	Parallel Phone Measurement Software*5 [requires MT8820C-012, the two same measurement hardware (2 board/set) and one measurement software]
W3320AE	Power Cord: 1 pc CF Card: 1 pc PC Card Adapter (For CF card): 1 pc MT8820C Operation Manual (CD-ROM): 1 pc	MX882012C	LTE FDD Measurement Software*2 (requires MT8820C-008)
	Options	MX882012C-006	LTE FDD IP Data Transfer*2 (requires MX882012C)
MT8820C-017	Extended RF Hardware*1	MX882012C-011	LTE FDD 2x2 MIMO DL*2,*6 (requires MT8820C-012 and MX882012C)
MT8820C-001	W-CDMA Measurement Hardware	MX882012C-016	LTE FDD CS Fallback to W-CDMA/GSM*7 (requires MX882012C)
MT8820C-002	TDMA Measurement Hardware	MX882012C-021	LTE-Advanced FDD DL CA Measurement Software*2,*8 (requires MT8820C-008 (2 sets), MT8820C-012, MX882010C, and MX882012C)
MT8820C-007	TD-SCDMA Measurement Hardware		
MT8820C-008	LTE Measurement Hardware	MX882012C-026	LTE-Advanced FDD DL CA IP Data Transfer*9 (requires MT8820C-008 (2 sets), MT8820C-012, MX882010C, MX882012C, MX882012C-006, MX882012C-021)
MT8820C-011	Audio Board	MX882012C-031	LTE-Advanced FDD DL CA 3CCs Measurement Software*2,*10 (requires MT8820C 2 sets. One is required MT8820C-008 (2 sets), MT8820C-012, MX882010C, MX882012C and MX882012C-021. The other is required MT8820C-008, MX882012C.)
MT8820C-012	Parallel Phone Measurement Hardware		
MT8820C-018	Extended RF 3.4 GHz to 3.8 GHz (requires MT8820C-017, MT8820C-119, or MT8820C-120)	MX882013C	LTE TDD Measurement Software*2 (requires MT8820C-008)
MT8820C-101	W-CDMA Measurement Hardware Retrofit	MX882013C-006	LTE TDD IP Data Transfer*2 (requires MX882013C)
MT8820C-102	TDMA Measurement Hardware Retrofit	MX882013C-011	LTE TDD 2x2 MIMO DL*2,*6 (requires MT8820C-012 and MX882013C)
MT8820C-107	TD-SCDMA Measurement Hardware Retrofit	MX882013C-016	LTE TDD CS Fallback to W-CDMA/GSM*11 (requires MX882013C)
MT8820C-108	LTE Measurement Hardware Retrofit	MX882013C-018	LTE TDD CS Fallback to TD-SCDMA/GSM*11 (requires MX882013C)
MT8820C-111	Audio Board Retrofit	MX882013C-021	LTE-Advanced TDD DL CA Measurement Software*2,*8 (requires MT8820C-008 (2 sets), MT8820C-012, MX882010C, and MX882013C)
MT8820C-112	Parallel Phone Measurement Hardware Retrofit		
MT8820C-119	Extended RF Hardware for SPM Retrofit	MX882013C-026	LTE-Advanced TDD DL CA IP Data Transfer*9 (requires MT8820C-008 (2 sets), MT8820C-012, MX882010C, MX882013C, MX882013C-006, MX882013C-021)
MT8820C-120	Extended RF Hardware for PPM Retrofit	MX882013C-031	LTE-Advanced TDD DL CA 3CCs Measurement Software*2,*10 (requires MT8820C 2 sets. One is required MT8820C-008 (2 sets), MT8820C-012, MX882010C, MX882013C, MX882013C-006, MX882013C-021. The other is required MT8820C-008, MX882013C.)
MT8820C-177	TD-SCDMA Measurement Retrofit (requires MT8820C-001)		
	Software options	MX882032C	CDMA2000 Measurement Software Lite*2
MX882000C	W-CDMA Measurement Software (requires MT8820C-001 and MX88205xC)	MX882036C	1xEV-DO Measurement Software Lite*2
MX882000C-001	W-CDMA Voice Codec (requires MT8820C-011 and MX882000C)	MX882036C-011	1xEV-DO Rev. A Measurement Software*2
MX882000C-011	HSDPA Measurement Software (requires MT8820C-001, MX882000C, and MX882050C)	MX882042C	LTE FDD Measurement Software Lite*2
MX882000C-013	HSDPA High Data Rate (requires MT8820C-001, MX882000C, MX882000C-011, and MX882050C)	MX882043C	LTE TDD Measurement Software Lite*2
MX882000C-021	HSUPA Measurement Software (requires MT8820C-001, MX882000C, MX882000C-011, and MX882050C)	MX882050C	W-CDMA Call Processing Software*2,*12 (requires MX882000C)
MX882000C-031	HSPA Evolution Measurement Software*2 (requires MT8820C-001, MX882000C, MX882000C-011, MX882000C-021, and MX882050C)	MX882050C-002	W-CDMA External Packet Data*2 (requires MX882050C)
MX882000C-032	DC-HSDPA Measurement Software*2,*3 (requires MT8820C-001 (2 sets), MT8820C-012, MX882000C, MX882000C-011, MX882000C-021, MX882000C-031, MX882010C, and MX882050C)	MX882050C-003	W-CDMA Video Phone Test*2 (requires MX882050C)
MX882000C-033	DC-HSUPA Measurement Software*2,*4 (requires MT8820C-001 (2 sets), MT8820C-012, MX882000C, MX882000C-011, MX882000C-021, MX882000C-031, MX882000C-032, MX882010C, MX882050C)	MX882050C-007	W-CDMA Band XII, XIII, XIV, XIX, XX, XXI*2,*13 (requires MX882050C)
MX882000C-034	4C-HSDPA Measurement Software*2,*4 (requires MT8820C-001 (2 sets), MT8820C-012, MX882000C, MX882000C-011, MX882000C-021, MX882000C-031, MX882000C-032, MX882010C, MX882050C)	MX882050C-008	W-CDMA Band XI*2 (requires MX882050C)
MX882001C	GSM Measurement Software (requires MT8820C-002)	MX882050C-009	W-CDMA Band IX*2 (requires MX882050C)
MX882001C-001	GSM Voice Codec (requires MT8820C-011 and MX882001C)	MX882050C-011	HSDPA External Packet Data*2 (requires MX882000C-011)
MX882001C-002	GSM External Packet Data (requires MX882001C)	MX882051C	W-CDMA Call Processing Software*2 (requires MX882000C)
MX882001C-011	EGPRS Measurement Software (requires MX882001C)	MX882051C-002	W-CDMA External Packet Data*2 (requires MX882051C)
MX882001C-041	GSM High-speed Adjustment (requires MX882001C)	MX882051C-003	W-CDMA Video Phone Test*2 (requires MX882051C)
MX882005C	PHS Measurement Software (requires MT8820C-002)	MX882070C	W-CDMA Ciphering Software*2 (requires MX882050C)
MX882005C-011	Advanced PHS Measurement Software (requires MX882005C)	MX882071C	W-CDMA Ciphering Software*2 (requires MX882051C)
MX882007C	TD-SCDMA Measurement Software (requires MT8820C-001 and MT8820C-007)		
MX882007C-001	TD-SCDMA Voice Codec (requires MT8820C-011 and MX882007C)	MT8820C-ES210	Warranty 2 years Extended Warranty Service
MX882007C-003	TD-SCDMA Video Phone Test (requires MX882007C)	MT8820C-ES310	3 years Extended Warranty Service
MX882007C-011	TD-SCDMA HSDPA Measurement Software*2 (requires MT8820C-001, MT8820C-007, and MX882007C)	MT8820C-ES510	5 years Extended Warranty Service
MX882007C-012	TD-SCDMA HSDPA Evolution Measurement Software*2 (requires MT8820C-001, MT8820C-007, MX882007C, MX882007C-011)		
		P0035B	Application parts W-CDMA/GSM Test USIM
		P0035B7	W-CDMA/GSM Test USIM*14
		P0135A6	Anritsu Test UICC GA (Nano UICC size)*15
		P0135A7	Anritsu Test UICC GA (Micro UICC size)*15
		P0250A6	Anritsu Test UICC GT (Nano UICC size)*15
		P0250A7	Anritsu Test UICC GT (Micro UICC size)*15
		P0260A6	Anritsu Test UICC GM (Nano UICC size)*15
		P0260A7	Anritsu Test UICC GM (Micro UICC size)*15
		P0135B6	Anritsu Test UICC GA (Nano UICC size)*15
		P0135B7	Anritsu Test UICC GA (Micro UICC size)*15
		P0250B6	Anritsu Test UICC GT (Nano UICC size)*15
		P0250B7	Anritsu Test UICC GT (Micro UICC size)*15
		P0260B6	Anritsu Test UICC GM (Nano UICC size)*15
		P0260B7	Anritsu Test UICC GM (Micro UICC size)*15
		A0058A	Handset

Model/Order No.	Name
J1195A J1249	PP2S Output Cable CDMA2000 Cable [D-Sub (15 pin, P-type) · D-Sub (15 pin, P-type), used in combination with J1267 (sold separately)]*16
J1267	CDMA2000 Cross Cable [D-Sub (9 pin, P-type) · D-Sub (9 pin, P-type), reverse cable used in combination with J1249 (sold separately)] Cable*16
J1606A	Coaxial Cord, 1 m (N-P · 5D-2W · N-P)
J0576B	Coaxial Cord, 2 m (N-P · 5D-2W · N-P)
J0576D	Coaxial Cord, 1 m (BNC-P · RG58A/U · BNC-P)
J0127A	Coaxial Cord, 0.5 m (BNC-P · RG58A/U · BNC-P)
J0127C	Coaxial Cord, 0.5 m (BNC-P · RG58A/U · BNC-P)
J0007	GPIB Cable, 1 m
J0008	GPIB Cable, 2 m
MN8110B	I/O Adapter (for call processing I/O)
B0332	Joint Plate (4 pcs/set)
B0643A	Rack Mount Kit (MT8820C)
B0499	Carrying Case (Hard type) (with protective cover and casters)
B0499B	Carrying Case (Hard type) (with protective cover, without casters)

- *1: MT8820C-017 has been a standard option that MT8820C are shipped with until July 2012 (Simultaneous order is required MT8820C and MT8820C-017).
- *2: For terminal connectivity, contact your Anritsu sales representative.
- *3: MX882000C-032 is required a Parallelphone measurement configuration of W-CDMA HSPA Evolution.
For use MT8820C 2 units, contact your Anritsu sales representative.
- *4: MX882000C-033 (034) is required W-CDMA DC-HSDPA configuration.
- *5: The following measurement hardware supports the Parallelphone measurement option: MT8820C-001, MT8820C-002, MT8820C-007, MT8820C-008.
All the measurement hardware can be installed simultaneously.
- *6: MX882012C-011 is required MT8820C-012.
- *7: The MX882012C-016 LTE FDD CS Fallback to W-CDMA/GSM requires a separate MT8820C with the W-CDMA/GSM configuration. Contact your Anritsu sales representative for the CS Fallback function test configuration.
- *8: MX882012C (12C)-021 is required a Parallelphone measurement configuration of LTE FDD (TDD).
For Use MT8820C 2 units, contact your Anritsu sales representative.
- *9: MX882012C (13C)-026 function test is required external server PCs (2 sets).
LTE Advanced FDD (TDD) DL CA IP Data Transfer (2CCs, 2Layer) is required MT8820C LTE 2x2 MIMO DL configuration (2 sets) and external server PCs (2 sets).
- *10: One is required LTE FDD (TDD) ParallelPhone Configuration.
The other is required LTE FDD Single Phone Configuration.
For use MT8820C 3 units, contact your Anritsu sales representative.
A synchronized cable is required too.
- *11: The MX882013C-016 (018) LTE TDD CS Fallback to W-CDMA/GSM (TD-SCDMA/GSM) requires a separate MT8820C with the W-CDMA/GSM (TD-SCDMA/GSM) configuration. Contact your Anritsu sales representative for the CS Fallback function test configuration.
- *12: These options preinstall the integrity protection function.
- *13: MX882050C-007 supports W-CDMA Band 12, 13, 14, 19, 20, 21.
- *14: The P0035B7 MicroSIM is a cut-down P0035B W-CDMA/GSM Test USIM. The P0035B7 Test USIM is a microSIM. It CANNOT be used in a normal size USIM card slot. A commercial SIM adapter CANNOT be used with the P0035B7.
If used, it may jam and break in the terminal.
- *15: Refer to the P0135Ax/P0250Ax/P0260Ax leaflet for details.
- *16: J1267 (J1606A) cable can use for LTE-Advanced DLCA synchronized cable.
Contact your Anritsu sales representative for details.

- Parallelphone™ is a registered trademark of Anritsu Corporation.
- CF® card is a registered trademark of SanDisk Corporation in the United States and is licensed to CFA (Compact Flash Association).

USED4TEST

Телефон: +7 (499) 685-7744

used@used4test.ru

www.used4test.ru